

CLARIDGE SERIES 1
SCALE - 1/2" = 1"

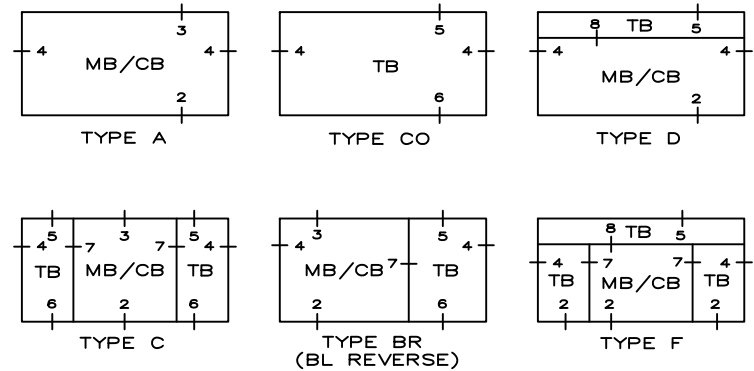
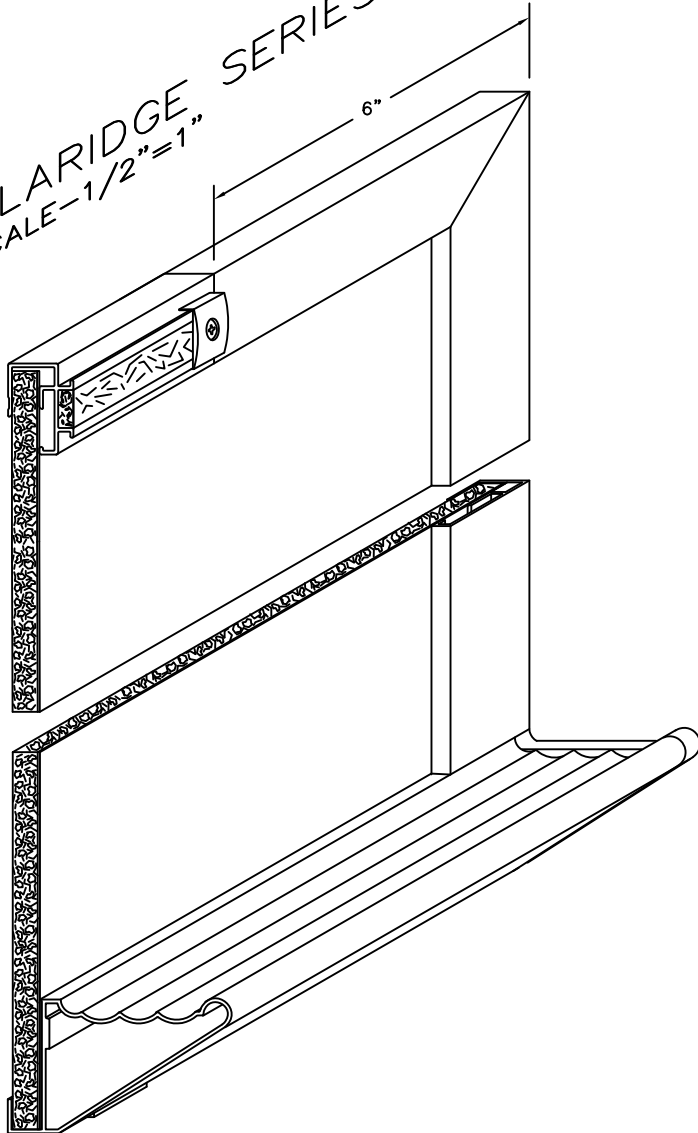

PANEL SIZES UP TO 4'-0" HIGH X 16'-0" WIDE IN ONE PIECE
ALL PANELS ARE APPROX. 1/2" THICK OVERALL

PORCELAIN ENAMEL PANEL TYPE	CORE	PANEL BACKING
NP CHALKBOARD	STANDARD CORE MDF	MOISTURE BARRIER BACK
LCS MARKERBOARD	OPTIONAL FORMALDEHYDE FREE CORE MDF	OPTIONAL FOIL SHEET ALUMINUM STEEL

TACKBOARD PANELS	SERIES NUMBER	PANEL MAKE-UP
CLARIDGE CORK	#1100	CLARIDGE COLORED CORK ON HARDBOARD
TAN NUCORK	#550	TAN NUCORK ON HARDBOARD
FABRICORK	#1550	VINYL FABRIC ON CORK UNDERLAY ON HARDBOARD
FABRICORK	#1380A	VINYL FABRIC ON DURACORE
DESIGNER SERIES	#3102	DESIGNER FABRIC ON CORK UNDERLAY ON HARDBOARD
HOOK-FAB	#934	HOOK-FAB ON CORK UNDERLAY ON HARDBOARD

CLARIDGE SERIES 1
 FACTORY BUILT UNITS
 TRIM SECTION DETAILS
 SCALE=FULL SIZE

