

CONNECT EXPRESSIONS INSTALLATION - Hardware kit

The hardware kit consists of at least two each of the following items:

1. z-clip - part no. 2739-clip
2. 3M dual lock washer - part no. HTA152
3. 3M dual lock strip - part no. HTA153

The quantity of each item will vary with board size.

Screws and hardware to attach hangers to the wall should be appropriate for the type of wall construction and are to be supplied by the installer.

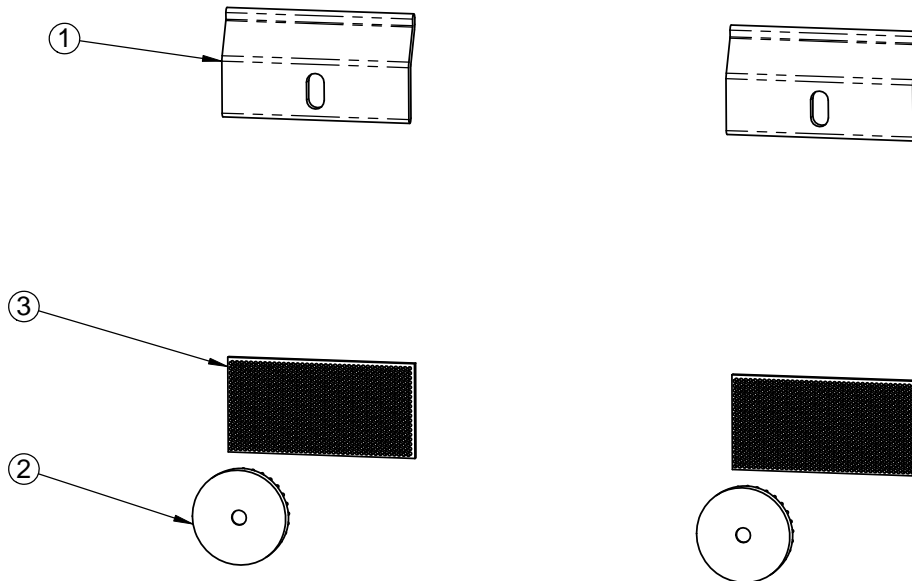

LANDSCAPE ORIENTATION

1. Measure 1 1/2" down from desired top edge of board.
2. Strike a level line at this location long enough to mount all boards to be hung at this level.
3. Strike a second level line for the lower hangers below the top hanger location, 1-3/4" less than the overall height of the board. For example if the board being installed is 18" overall height the location for the lower hangers will be 16 1/4" below the desired top edge of the board.
4. If the board(s) is 48" in overall height or greater, strike a third level line at the horizontal center line of the board(s).

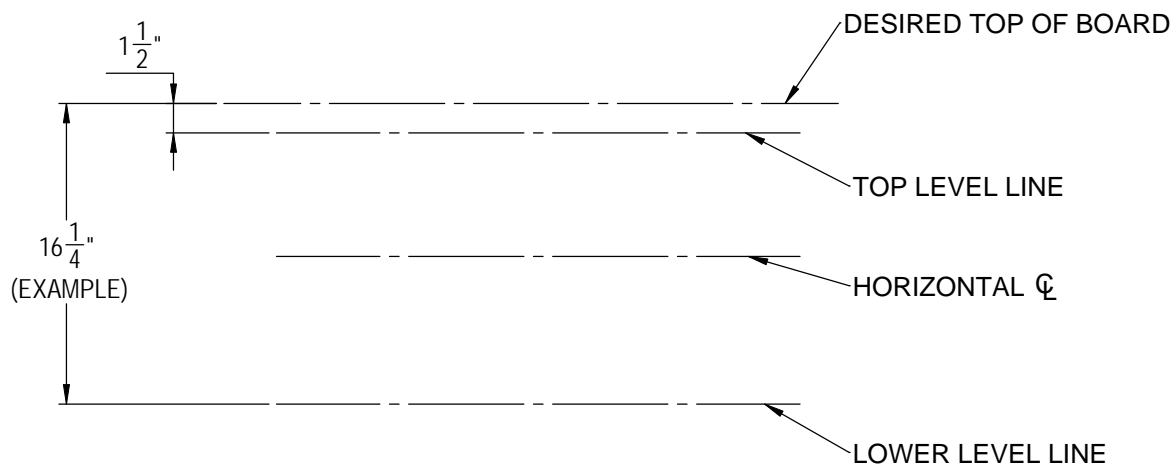

PORTRAIT ORIENTATION (60" - 96" IN HEIGHT)

1. SEE STEPS 1 AND 2 ABOVE.
2. STRIKE A VERTICAL LINE 3" INWARD FROM THE DESIRED LEFT EDGE OF THE BOARD.
3. REPEAT FOR THE DESIRED RIGHT EDGE OF THE BOARD.
4. STRIKE A VERTICAL CENTER LINE THE HEIGHT OF THE BOARD.

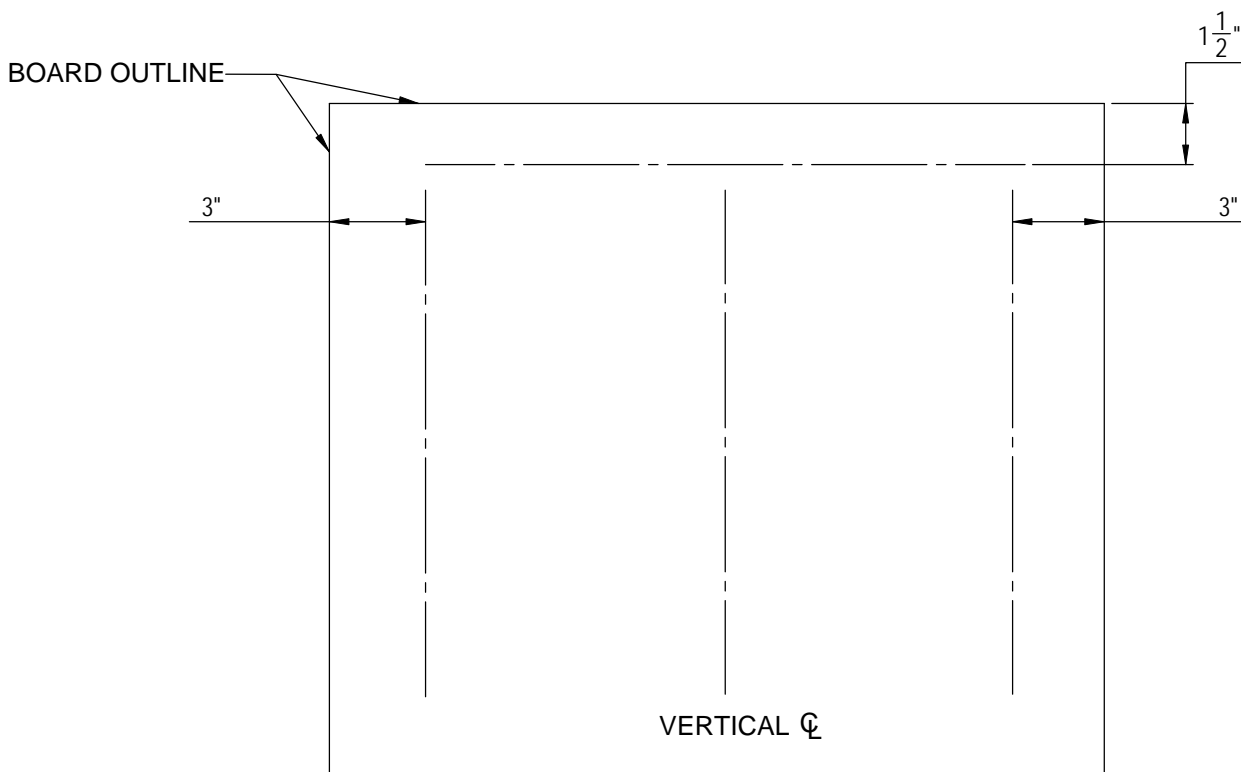

LANDSCAPE ORIENTATION

- Using screws and necessary anchors appropriate for the type of wall construction, mount the top z-clips to the wall along the top level line as shown below. The clips should be spaced such that they will be inside the trim of the board being installed. If the board is of such size that more than two z-clips are required the remaining z-clips should be equally distributed along the top level line between the two outside z-clips. (Screws and anchors not included.)
- Using screws and necessary anchors appropriate for the type of wall construction, mount the dual lock washers at the lower level line and if required the horizontal centerline. See the below pattern that best applies to the size of board being installed. Depending upon the orientation of the board there may be Dual Lock washers and tabs remaining when the installation is complete.
- Once the hangers are mounted, press dual lock tabs onto the dual lock washers.

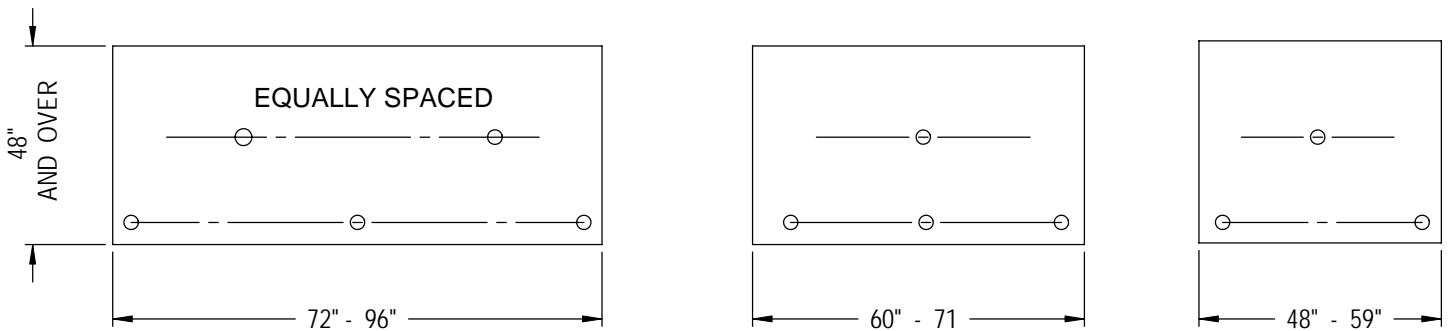
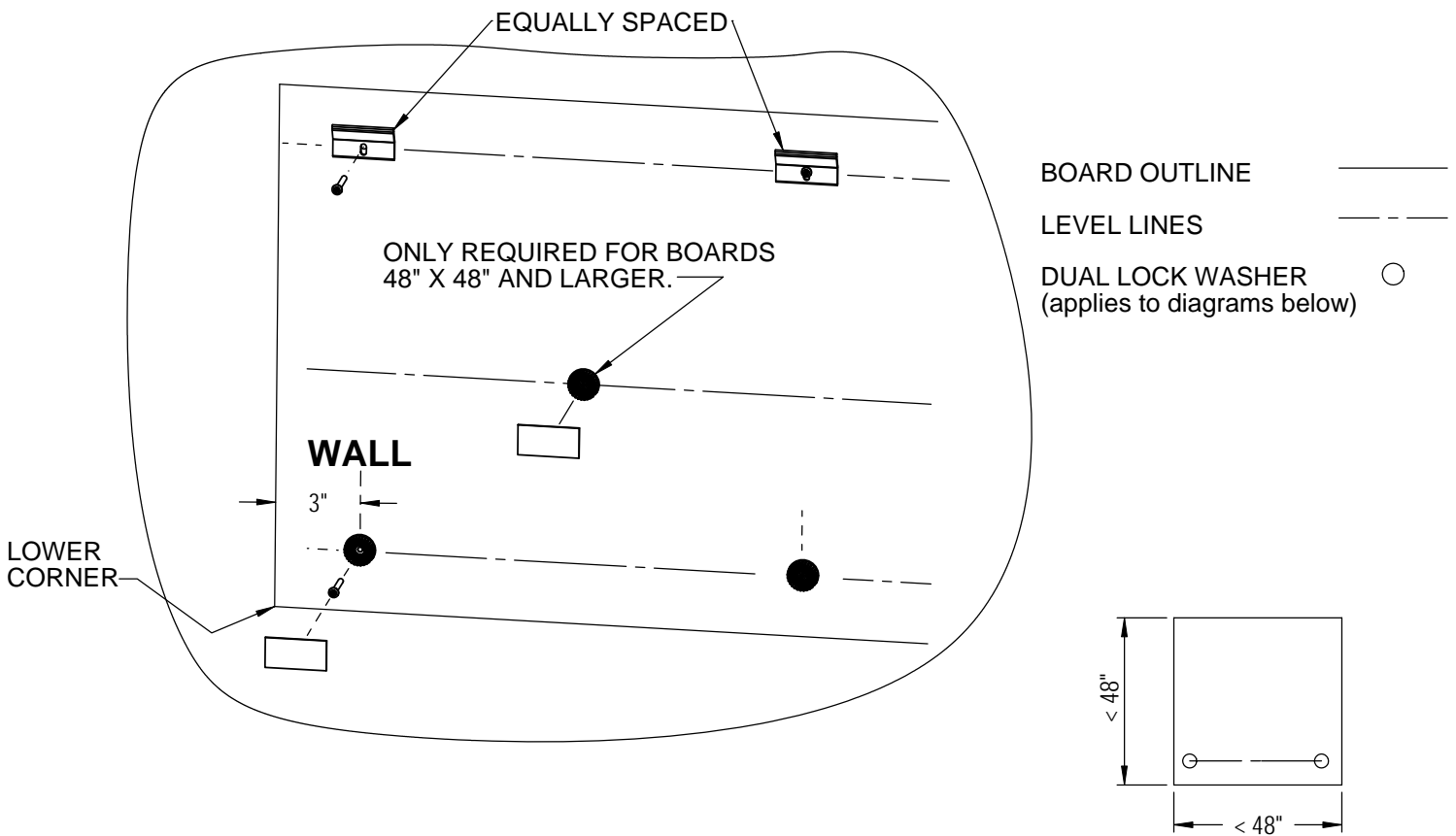

PORTRAIT ORIENTATION

1. *SEE INSTRUCTIONS ON LANDSCAPE ORIENTATION FOR HARDWARE MOUNTING INSTRUCTIONS (PAGE 3).*
2. Mount the dual lock washers along the vertical mounting lines in the patterns that best apply to the size of board being installed as described below. For boards smaller than 60" see the landscape orientation diagrams.
3. Once the hangers are mounted, press dual lock tabs onto the dual lock washers.

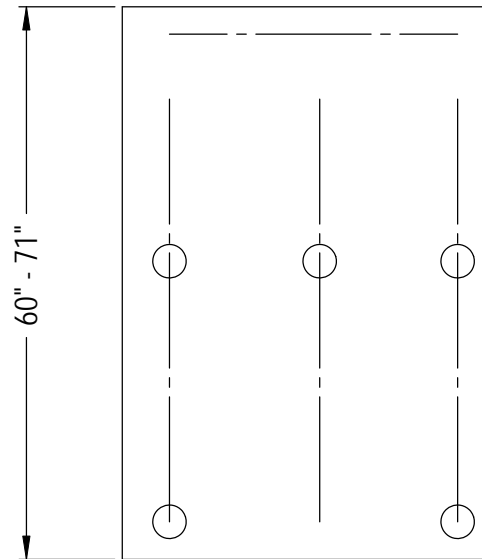
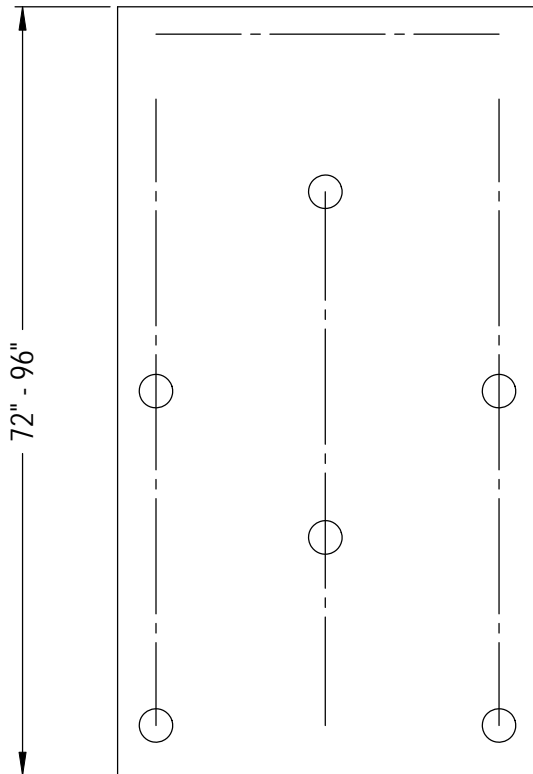

CONNECT EXPRESSIONS INSTALLATION - Board mounting

1. Peel backing off of dual lock tabs exposing the adhesive surface.
2. Hang board on z-clips.
3. By hand, firmly press on lower corners of board to seat board onto the adhesive back of the dual lock tab. Repeat for the center dual lock tab if included in the installation.

****When installing tack or cork boards ensure hands are clean to prevent marring cork or fabric surface.****

